

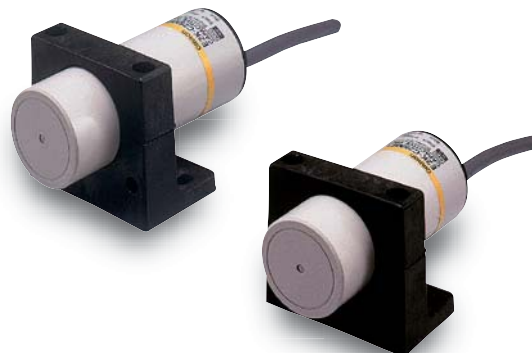

Long-distance Capacitive Sensor with Adjustable Sensitivity





- CE Marking for DC 3-wire models and AC/DC 2-wire models.
- Noise-resistant models are also available for environments with strong noise.



 Be sure to read *Safety Precautions* on page 7.

Ordering Information

Sensors [Refer to *Dimensions* on page 8.]

Appearance		Sensing distance			Model		
					Output configuration	Operation mode	
						NO	NC
Standard Models	Unshielded  34 dia.		3 to 25 mm	DC 3-wire, NPN	E2K-C25ME1 2M	E2K-C25ME2 2M	
				AC 2-wire	E2K-C25MY1 2M	E2K-C25MY2 2M	
Noise-resistant Models	 34 dia.		3 to 20 mm	DC 3-wire, NPN	E2K-C20MC1 2M	E2K-C20MC2 2M	
				AC/DC 2-wire	E2K-C20MT1 2M	E2K-C20MT2 2M	

Accessories (Order Separately)

Mounting Brackets A Mounting Bracket is provided.

[Refer to *Dimensions* on page 8.]

Appearance	Model	Quantity	Remarks
	Y92E-A34	1	Provided with the product.

Ratings and Specifications

Standard Models

Item	Model	E2K-C25ME1	E2K-C25ME2	E2K-C25MY1	E2K-C25MY2
Sensing distance*		25 mm			
Sensing area		3 to 25 mm			
Detectable object		Conductors and dielectrics			
Standard sensing object		Grounded metal plate: 50 × 50 × 1 mm			
Differential travel		15% max. of sensing distance (when adjusted to 25 mm ±10% with standard sensing object)			
Response frequency		70 Hz		10 Hz	
Power supply voltage (operating voltage range)		12 to 24 VDC (10 to 40 VDC), ripple (p-p): 10% max.		100 to 220 VAC (90 to 250 VAC), 50/60 Hz	
Current consumption		E Models: 10 mA max. at 12 VDC, 16 mA max. at 24 VDC			
Leakage current		Y Models: 1 mA max. at 100 VAC (50/60 Hz) with output turned OFF, 2 mA max. at 200 VAC (50/60 Hz) with output turned OFF			
Control output	Load current	200 mA max.		5 to 200 mA (resistive load)	
	Residual voltage	2 V max. (Load current: 200 mA, Cable length: 2 m)		Refer to <i>Engineering Data</i> on page 4.	
Indicators		Detection indicator (red)		Operation indicator (red)	
Operation mode (with sensing object approaching)		E1/Y1 Models: NO E2/Y2 Models: NC Refer to the timing charts under <i>I/O Circuit Diagrams</i> on page 5 for details.			
Protection circuits		Reverse polarity protection, Surge suppressor		Surge suppressor	
Ambient temperature range		Operating/Storage: -25 to 70°C (with no icing or condensation)			
Ambient humidity range		Operating/Storage: 35% to 95% (with no condensation)			
Temperature influence		±15% max. of sensing distance at 23°C in the temperature range of -10 to 55°C ±25% max. of sensing distance at 23°C in the temperature range of -25 to 70°C			
Voltage influence		±2% max. of sensing distance at the rated voltage in rated voltage ±15% range		±2% max. of sensing distance at the rated voltage in rated voltage +20%, -10% range at 100 VAC, ±20% range at 200 VAC	
Insulation resistance		50 MΩ min. (at 500 VDC) between current-carrying parts and case			
Dielectric strength		1,000 VAC, 50/60 Hz for 1 min between current-carrying parts and case		1,500 VAC, 50/60 Hz for 1 min between current-carrying parts and case	
Vibration resistance		Destruction: 10 to 55 Hz, 1.5-mm double amplitude for 2 hours each in X, Y, and Z directions			
Shock resistance		Destruction: 500 m/s ² 10 times each in X, Y, and Z directions			
Degree of protection		IEC 60529 IP66			
Connection method		Pre-wired Models (Standard cable length: 2 m)			
Weight (packed state)		Approx. 200 g			
Materials	Case	Heat-resistant ABS			
	Sensing surface				
Accessories		Mounting Bracket, M4 screws, Instruction manual			

* The set distances are sensing distances applicable to standard sensing objects. Refer to *Engineering Data* on page 4 for other materials.

Noise-resistant Models

Item	Model	E2K-C20MC1	E2K-C20MC2	E2K-C20MT1	E2K-C20MT2
Sensing distance *1		20 mm			
Sensing area		3 to 20 mm			
Detectable object		Conductors and dielectrics			
Standard sensing object		Grounded metal plate: 50 × 50 × 1 mm			
Differential travel		15% max. of sensing distance (when adjusted to 20 mm ±10% with standard sensing object)			
Response frequency *2		40 Hz		AC power: 25 Hz, DC power: 40 Hz	
Power supply voltage (operating voltage range)		12 to 24 VDC (10 to 36 VDC), ripple (p-p): 10% max.		24 to 240 VAC (20 to 250 VAC), 50/60 Hz; 24 to 240 VDC (20 to 250 VDC)	
Current consumption		13 mA max. at 24 VDC		---	
Leakage current		---		1.5 mA max. at 24 VDC, 1.7 mA max. at 110 VAC (50/60 Hz), 2.5 mA max. at 250 VAC (50/60 Hz) Refer to <i>Engineering Data</i> on page 4.	
Control output	Load current	250 mA max.		5 to 200 mA (resistive load)	
	Residual voltage	2.5 V max. (Load current: 250 mA, Cable length: 2 m)		AC power: 10 V max., DC power: 8 V max. Refer to <i>Engineering Data</i> on page 4.	
Indicators		Operation indicator (yellow)			
Operation mode (with sensing object approaching)		C1/T1 Models: NO C2/T2 Models: NC Refer to the timing charts under <i>I/O Circuit Diagrams</i> on page 5 for details.			
Protection circuits		Reverse polarity protection, Load short-circuit protection		---	
Ambient temperature range		Operating/Storage: -25 to 70°C (with no icing or condensation)			
Ambient humidity range		Operating/Storage: 35% to 95% (with no condensation)			
Temperature influence		±15% max. of sensing distance at 23°C in the temperature range of -10 to 55°C ±25% max. of sensing distance at 23°C in the temperature range of -25 to 70°C			
Voltage influence		±2% max. of sensing distance at the rated voltage in rated voltage ±15% range			
Insulation resistance		50 MΩ min. (at 500 VDC) between current-carrying parts and case			
Dielectric strength		1,000 VAC, 50/60 Hz for 1 min between current-carrying parts and case		1,500 VAC, 50/60 Hz for 1 min between current-carrying parts and case	
Vibration resistance		Destruction: 10 to 55 Hz, 1.5-mm double amplitude for 2 hours each in X, Y, and Z directions			
Shock resistance		Destruction: 500 m/s ² 10 times each in X, Y, and Z directions			
Degree of protection		IEC 60529 IP65			
Connection method *3		Pre-wired Models (Standard cable length: 2 m)			
Weight (packed state)		Approx. 240 g			
Materials	Case	PBT			
	Sensing surface				
Accessories		Mounting Bracket, M4 screws, Instruction manual			

*1. The set distances are sensing distances applicable to standard sensing objects. Refer to *Engineering Data* on page 4 for other materials.

*2. The response frequency is an average value.

*3. Only 2-m cables are available. Use a cable with a conductor cross section of 0.5 mm² or greater to extend the cable.

Engineering Data (Typical)

Common Mode Continuous Noise

E2K-C20M

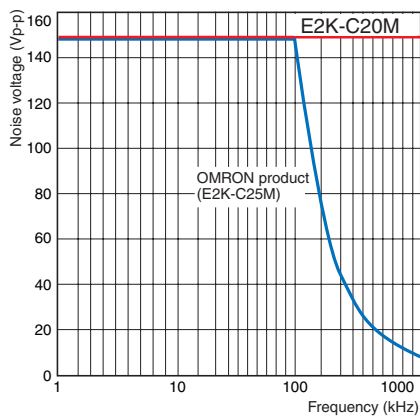

Sensing Distance Change by Sensing Object

E2K-C25M

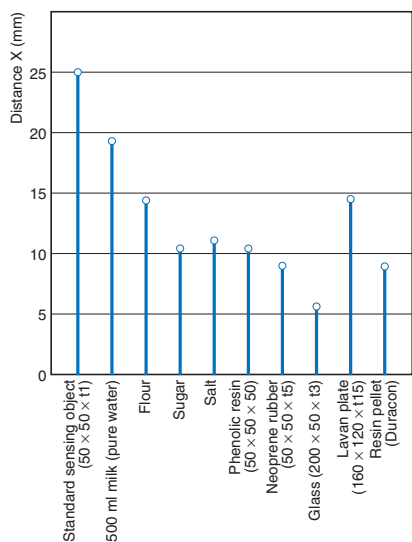

E2K-C20M

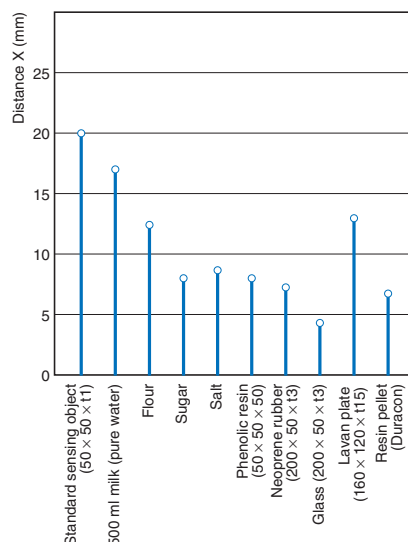

Residual Output Voltage

E2K-C25MY at 100 VAC

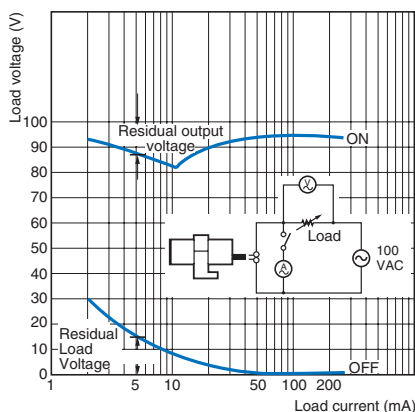

E2K-C25MY at 200 VAC

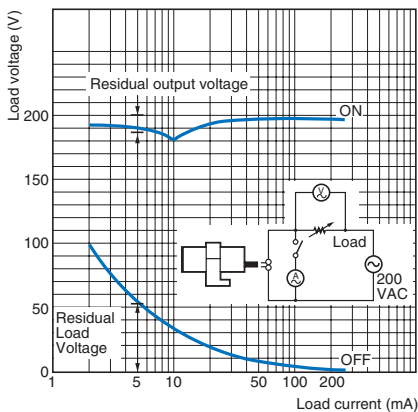

Leakage Current

E2K-C25MY

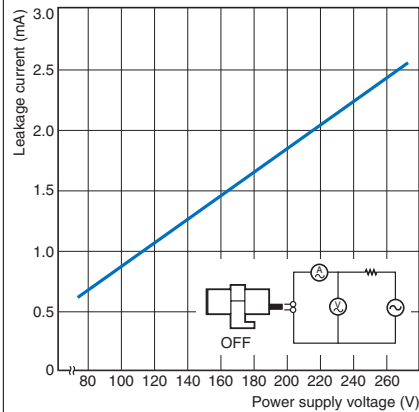

E2K-C20MT at 100 VAC

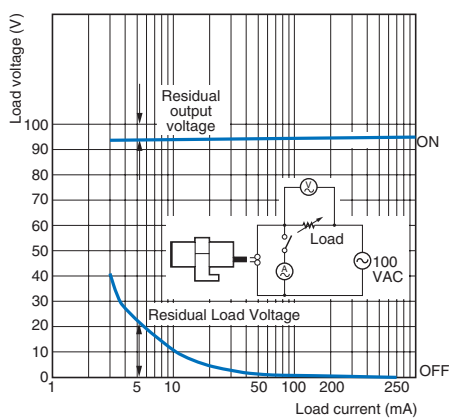

E2K-C20MT at 200 VAC

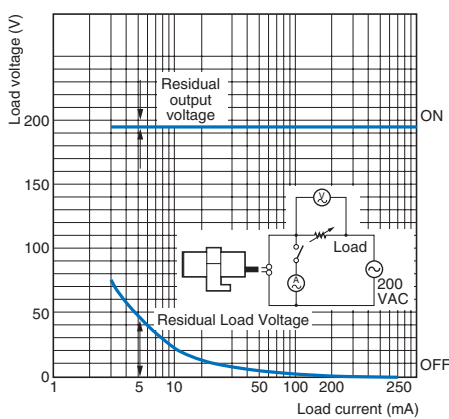

E2K-C20MT

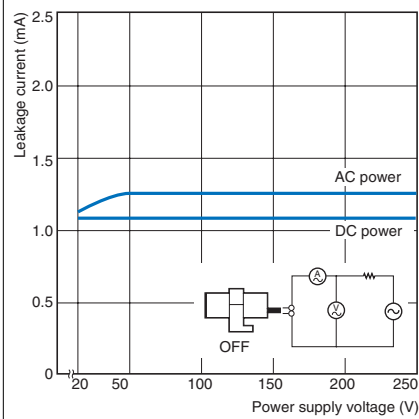

Sensing Area (Grounded Metal Plate)

E2K-C25M□□

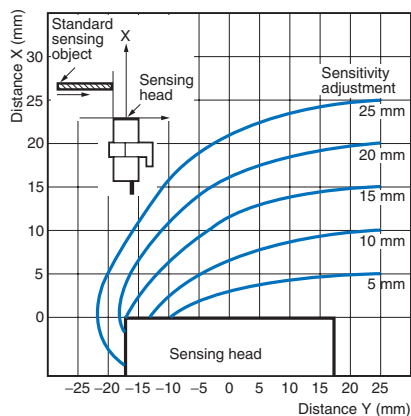

Sensing Object Size vs. Sensing Distance

E2K-C25M□□

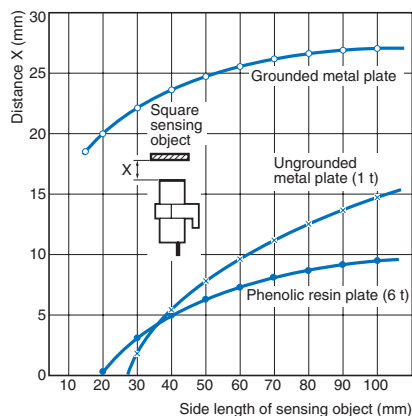

Sensing area

E2K-C20M□□

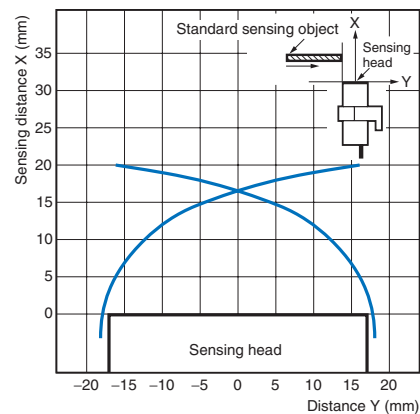

I/O Circuit Diagrams

DC 3-Wire Models

Operation mode	Model	Timing chart	Output circuit
NO	E2K-C25ME1	<p>Sensing object: Present (High), Not present (Low)</p> <p>Load (between brown and black leads): Operate (High), Reset (Low)</p> <p>Output voltage (between black and blue leads): High, Low</p> <p>Detection indicator (red): ON, OFF</p>	<p>*1. Load current: 200 mA max. *2. When a transistor is connected.</p>
NC	E2K-C25ME2	<p>Sensing object: Present (High), Not present (Low)</p> <p>Load (between brown and black leads): Operate (High), Reset (Low)</p> <p>Output voltage (between black and blue leads): High, Low</p> <p>Detection indicator (red): ON, OFF</p>	
NO	E2K-C20MC1	<p>Sensing object: Present (High), Not present (Low)</p> <p>Load (between brown and black leads): Operate (High), Reset (Low)</p> <p>Operation Indicator (yellow): ON, OFF</p>	
NC	E2K-C20MC2	<p>Sensing object: Present (High), Not present (Low)</p> <p>Load (between brown and black leads): Operate (High), Reset (Low)</p> <p>Operation Indicator (yellow): ON, OFF</p>	<p>* Load current: 250 mA max.</p>

AC 2-Wire Models

Operation mode	Model	Timing chart	Output circuit
NO	E2K-C25MY1		
NC	E2K-C25MY2		

AC/DC 2-Wire Models

Operation mode	Model	Timing chart	Output circuit
NO	E2K-C20MT1		<p>* Load current: 200 mA max.</p>
NC	E2K-C20MT2		

Safety Precautions

Refer to *Warranty and Limitations of Liability*.

⚠ WARNING

This product is not designed or rated for ensuring safety of persons either directly or indirectly. Do not use it for such purposes.



Precautions for Correct Use

Do not use this product under ambient conditions that exceed the ratings.

● Design

Influence of Surrounding Metal

When mounting a Proximity Sensor, be sure to provide a distance of 80 mm min. from surrounding metal objects to prevent the Sensor from being affected by metal objects other than the sensing object. When mounting the Sensor with the L-shaped Mounting Bracket, be sure to provide a distance of 20 mm min. between the face of the sensing head and the Mounting Bracket.

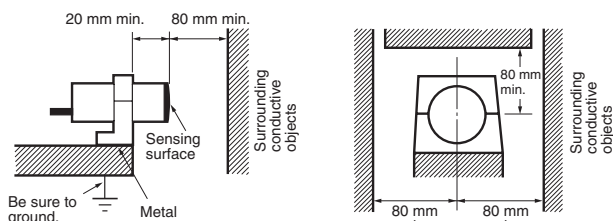

Mutual Interference

When installing Sensors face-to-face or side-by-side, ensure that the minimum distances given in the following table are maintained.

Face-to-face Mounting

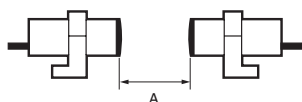

Parallel Mounting

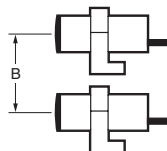

Mutual Interference (Unit: mm)

Dimension	A	B
Model		
E2K-C25M□□	100	100
E2K-C20M□□		105

Effects of a High-frequency Electromagnetic Field

The E2K-C may malfunction if there is an ultrasonic washer, high-frequency generator, transceiver, portable telephone or inverter nearby.

For major measures, refer to *Noise of Warranty and Limitations of Liability* for Photoelectric Sensors.

Sensing Objects

● Sensing Object Material

The E2K-C can detect almost any type of object. The sensing distance of the E2K-C, however, will vary with the electrical characteristics of the object, such as the conductance and inductance of the object, and the water content and capacity of the object. The maximum sensing distance of the E2K-C will be obtained if the object is made of grounded metal.

● Indirect Detection

To detect objects in metal containers, each metal container must have a nonmetallic window.

Power ON Conditions

Sensing is enabled within 200 ms for the E2K-C20M□□. Design the system so that the power for the Sensor is turned ON before the power for the load.

● Miscellaneous

Organic Solvents

The Sensor has a case made of heat-resistant ABS resin or PBT resin. Be sure that the case is free from organic solvents or solutions containing organic solvents.

Dimensions

Sensors

E2K-C25M□□

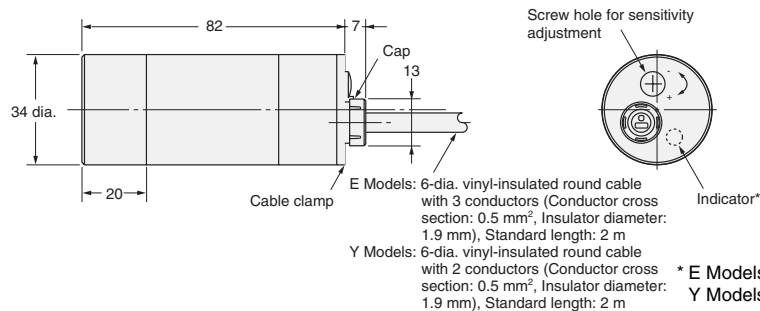
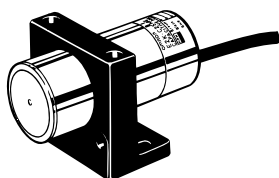

* E Models: Detection indicator (red)
Y Models: Operation indicator (red)

E2K-C20M□□

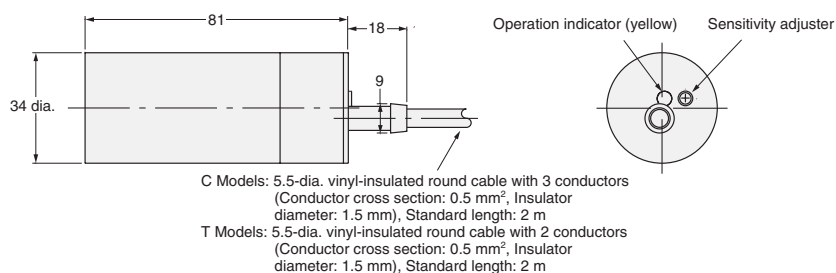

Accessories (Order Separately)

Mounting Bracket (Accessory)

Y92E-A34

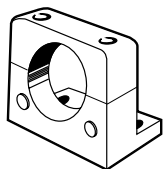

Material: Polyacetal

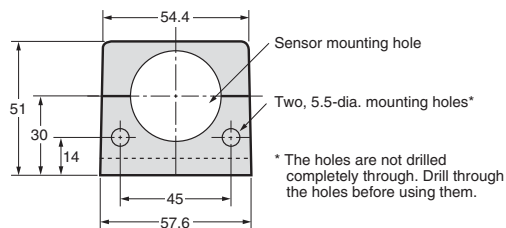
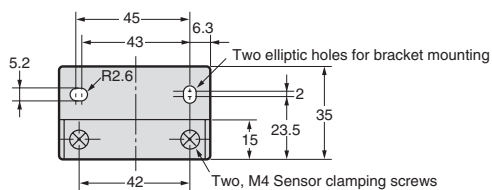

With Mounting Bracket Attached

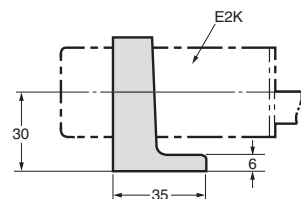

Note: Provided with the product.